

PFI-9602 C Series Module

2-Channel Programmable 6-Pole Filter/Amplifier for Voltage Input

 PRECISION
FILTERS, INC.

- High-performance analog input/output modules for use in any National Instruments™ CompactDAQ™ or CompactRIO™ chassis
- Provides protection against aliasing in front of NI™ C Series analog to digital converters
- 2 channels per module
- Balanced differential input
- Programmable AC/DC coupling
- Programmable gain, x1 to x3000
- Programmable FLAT/PULSE 6-pole low-pass filter; 10 to 100 kHz programmable bandwidth
- Test bus for system calibration signal injection
- Support for IEPE microphones or accelerometers via optional current source accessory
- -40 to 70°C operating range

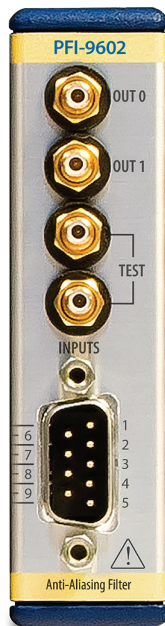

The PFI-9602 amplifier provides precise low-noise and wide bandwidth amplification to low-level voltage signals. The sharp, selective response of the filters allows for lower sampling rates for required alias protection. Outstanding channel-to-channel phase and amplitude match makes the PFI-9602 ideal for applications where time coherence between channels must be maintained.

The PFI-9602 is equipped with a fully programmable 6-pole, 6-zero low-pass filter and a distributed gain amplifier. The low-pass filters may operate either in a “flat” mode for maximally flat pass-band amplitude response with sharp roll-off or in a “pulse” mode for low phase distortion and optimized transient response. The “flat” mode provides pass-band characteristics nearly identical to a Butterworth filter while providing a much sharper roll-off. This mode provides optimal response for applications such as spectral analysis. The “pulse” mode has transient response similar to the Bessel filter yet provides superior amplitude characteristics. The “pulse” mode is ideal for time domain applications including transient (shock) measurements and waveform analysis.

The filter cutoff frequency may be programmed from 10 Hz to 100 kHz in over 200 steps. Gain is programmable from 1 to 3000 and is distributed around the filter to provide protection against large out-of-band energy or transients present in resonant sensors that could cause clipping before the filter, distorting the data. The optional current source accessory allows for direct connection to IEPE microphones or accelerometers.

Description

Precision Filters, Inc. model PFI-9602 C Series™ module provides two channels of high-performance programmable low-pass filter amplifiers. The module outputs may be connected to a suitable National Instruments™ C Series analog input A/D module to form a complete signal measurement system.

The 9602 features Precision Filters’ FLAT/PULSE low-pass filter technology, allowing the frequency response to be programmed either for frequency-domain spectrum analysis applications or for time domain analysis such as shock.

The module is fully compatible with National Instruments CompactDAQ™ or CompactRIO™ hardware family that features more than 50 measurement modules and several sizes of chassis and carriers for deployment.

Applications

- Transient (shock) measurements
- Underwater acoustics and sonar
- Modal analysis and vibration
- Acoustics
- IEPE sensor conditioner
- Anti-aliasing filter
- Reconstruction filter

Specifications

Input Characteristics:

Type:

Balanced differential input with programmable AC/DC coupling

Input Impedance: 10 M Ω || 3 pF per side

Programmable AC Coupling Frequency:

0.25 Hz (-3.01 dB)

Max Level (AC + DC + Common Mode):

± 5 Vpk for $f \leq 127$ kHz; ± 5 Vpk x (127 kHz/f) for $f > 127$ kHz

Protection:

15 V continuous, 50 Vpk for 1 mS, 10% duty cycle

Noise:

RES OFF: 12 nV per root Hz RTI at 1 kHz & gain $\geq \times 100$

RES ON: 12 nV per root Hz RTI at 1 kHz & gain $\geq \times 1000$

Drift: 2 μ V/ $^{\circ}$ C, RTI

CMRR:

DC Coupled: $G \geq 10$, RES OFF; $G \geq 100$ RES ON
100 dB, DC to 1 kHz; 80 dB, 1 kHz to 10 kHz

AC Coupled: $G \geq 10$, RES OFF; $G \geq 100$ RES ON
80 dB, 50 Hz to 10 kHz

Sensor MUTE Mode:

Terminate unused channels or channels with faulty sensors in quietest state

IEPE Input Option (Option I):

Requires PFI-IEPE-9602 Input Adapter Accessory

Type: AC-Coupled single-ended input

Input Connectors: 2 ea. Microdot (10-32) inputs

Current Source: 2.5 mA, nominal

Current Source Compliance Voltage: 22 V

AC Coupling Frequency: 0.5 Hz

Amplifier:**Programmable Gain:**

x1, 3, 10, 30, 100, 300, 1000, 3000

Out-Band Reserve:

Gain is distributed around the filter to accommodate and remove out of band signals larger than the in-band signal of interest without signal clipping.

Reserve Settings: OFF (3) or ON (30)

DC Accuracy: 0.1%

DC Temperature Coefficient: $\pm 0.001\%$ / $^{\circ}$ C

DC Linearity:

0.01% re: Full-scale, relative to best straight line

Analog Filter:**Type:**

Programmable (FLAT/PULSE) LP6FP 6-pole, 6-zero low-pass filter. Programmable for maximally flat pass-band (LP6F) or linear phase with optimized pulse response (LP6P).

Programmable Cutoff Frequencies:

10 Hz to 1.27 kHz in 10 Hz steps

2 kHz to 127 kHz in 1 kHz steps

Pass-Band Accuracy, DC to 0.8 Fc (Fc < 25 kHz):

LP6P: ± 0.1 dB

LP6F: ± 0.15 dB

Pass-Band Accuracy, DC to 0.8 Fc (Fc \geq 25 kHz):

LP6P: ± 0.2 dB

LP6F: ± 0.4 dB

Test Modes:**Amplifier Short:**

A switch at the amplifier input is utilized to ground the input stage for measurement of noise and DC offset.

Test Bus:

A switch at the channel input allows for automated injection of an external calibration signal via front panel SMB connectors. A second SMB connector allows the test bus signal to be daisy chained across multiple modules.

Output:

Type: Single-ended

Impedance: 10 Ω || 10 pF

Max Output: ± 5 Vpk, ± 2 mApk

DC Offset: <5 mV after auto adjust at any gain setting

Offset Drift: 2 μ V/ $^{\circ}$ C, RTI + 150 μ V/ $^{\circ}$ C RTO

Crosstalk: -80 dB DC to 40 kHz

Noise: 4 μ Vrms RTI + 120 μ Vrms RTO

Programming:

There are two methods of controlling the settings of the PFI-9602.

- A) PFI supplied LabView™ Driver VI to control the module from a LabView project.
- B) Alternately, stand-alone turnkey signal conditioning systems supplied by Precision Filters can be controlled using PFI executable GUI requiring no software programming. Stand-alone system require use of NI 9146 4-slot or 9149 8-slot chassis.

Power: 950 mW maximum

Isolation:

60 V DC or AC continuous Bank isolation, channel to earth ground

The PFI-9602 has a flexible high performance 6-pole low-pass filter characteristic that can be optimized for time or frequency domain measurements.

LP6F and LP6P Amplitude Response

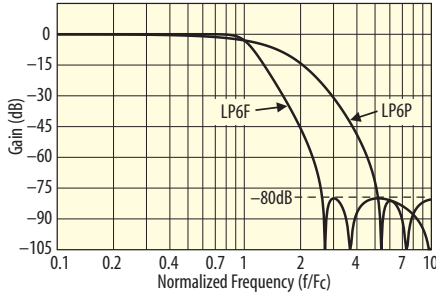

Flat/Pulse Low-Pass Filters

The LP6F and LP6P 6-pole low-pass filters have the versatility to address applications in either the time or frequency domain. Simply program the filter characteristic to match your measurement requirements.

Flat Mode Low-Pass Filters

The LP6F FLAT mode characteristic has a pass-band amplitude response nearly identical to the 6-pole Butterworth yet has much sharper roll-off characteristics. This makes the LP6F a good choice for spectral analysis or for anti-aliasing applications.

LP6F vs. 6-Pole Butterworth Amplitude Response

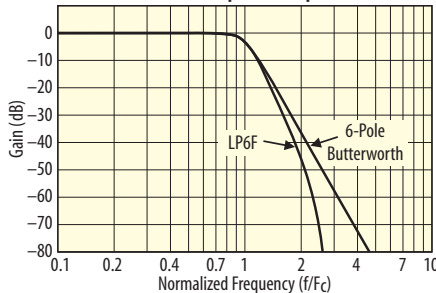

The LP6F may be used to effectively reduce resonant peaking of transducers while maximizing the useable bandwidth.

LP6F Attenuation of Transducer Resonance (Q = 10) at 5 * Fc

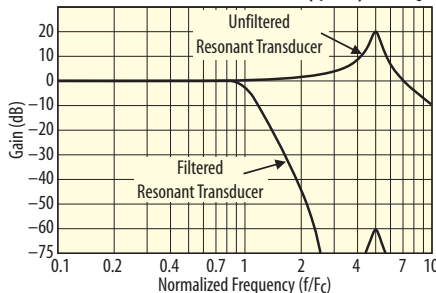

The input to output time delay of the LP6F and Butterworth are not constant versus frequency as a consequence of the non-linear phase property of these filters. Filters with linear phase, such as the Precision LP6P, have linear phase and thus constant delay for all frequencies in the pass-band.

LP6F & LP6P Phase Delay

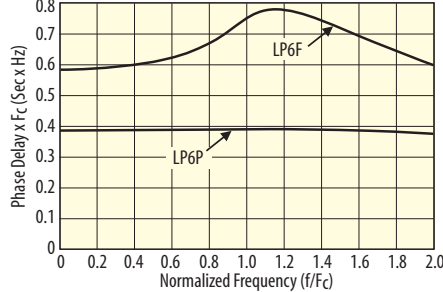

Pulse Mode Low-Pass Filters

For the time domain, the LP6P PULSE mode low-pass filter has excellent transient response and phase linearity required for time domain applications such as transient (shock) measurements and time domain waveform analysis.

LP6F & LP6P Step Response

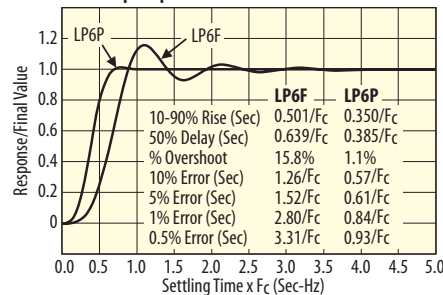

When compared to a 6-pole Bessel filter, the LP6P has similar pass-band characteristics yet has much sharper transition slope from pass-band to stop-band.

LP6P vs. 6-Pole Bessel Amplitude Response

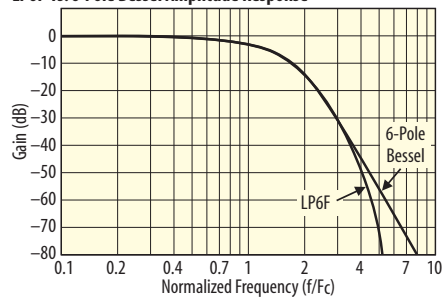

Anti-Aliasing Applications

When used for anti-aliasing applications, the LP6F provides more useable bandwidth for a given sampling frequency.

LP6F Attenuation of Aliases vs Sampling Frequency

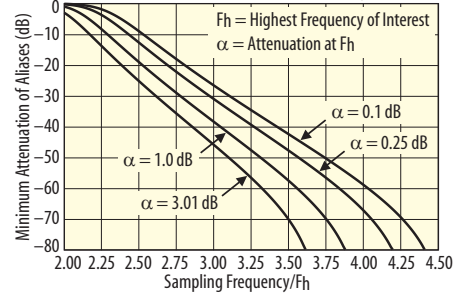

In exchange for linear phase and excellent transient response, the LP6P is less selective and thus requires a higher sampling frequency than the LP6F.

LP6P Attenuation of Aliases vs Sampling Frequency

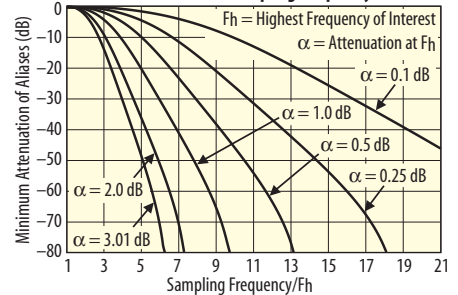

The chart below provides a comparison of attenuation of aliases versus sampling frequency for the LP6P, 6-pole Bessel (BE6), LP6F and the 6-pole Butterworth (BU6). It is clear that much lower sampling frequencies are required for the Precision LP6P and LP6F when compared to traditional filter characteristics.

| Alias Attn. | Sampling Frequency for -3.01 dB Attenuation @ Fh | | | |
|-------------|--|-------|-------|-------|
| | BE6 | LP6P | BU6 | LP6F |
| 20 | 3.4Fc | 3.4Fc | 2.5Fc | 2.4Fc |
| 40 | 4.6Fc | 4.5Fc | 3.2Fc | 2.9Fc |
| 60 | 6.4Fc | 5.5Fc | 4.2Fc | 3.3Fc |
| 80 | 9.0Fc | 6.2Fc | 5.6Fc | 3.6Fc |

Certifications

CE, EX European Union Hazardous Locations, ROHS

Safety Standards:

EN 61010-1

EMC Standards:

EN 61326-1

Hazardous Location Standards:

EN 60079-0 & EN 60079-15

Physical:

NI C Series Compatible

Input Connector: 9-pin D sub

Output Connector: 2 ea. SMB jack

Test Bus Connector: 2 ea. SMB jack

Weight: 6 oz.

Accessories

PFI-IEPE-9602 Input Adapter:

2 ea. Microdot Input Connectors supply 2.5 mA IEPE current source to connected sensor

CONN-IN-9D Mating Input Connector with metal backshell and crimp contacts

CONN-IN-9D-SC Mating Input Connector with metal backshell and solder cup contacts

CONN-IN-9D-SCT Mating Input Connector with metal backshell and screw terminal connections

CB-SMB/BNCM-L: SMB plug to BNC male cable;
L = 0.5, 1, 3, 10 feet

CB-SMB/PIGTAIL-L:

SMB plug to prepped/tinned leads for NI screw terminal connections; L = 0.5, 1, 3, 10 feet

CB-16XSMB/DC37S-L:

16 SMB plug to DC37 sockets for connection to NI 9220; L = 1, 3 feet

CB-SMB/SMB-L:

SMB plug to SMB plug cable for bussing test input; L = 0.5, 1 feet

PFI-IEPE-9602 Input Adapter Diagram

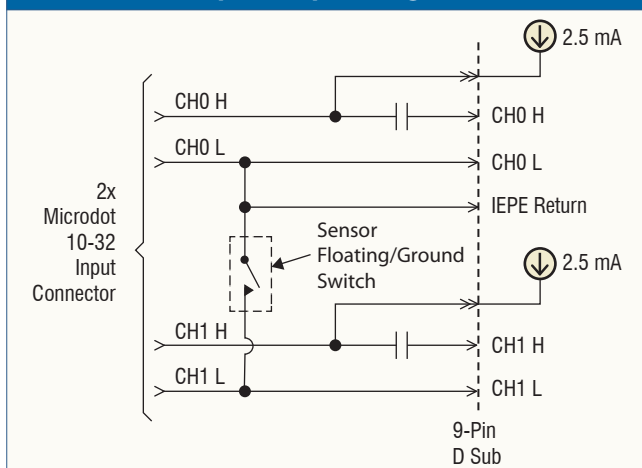

Ordering Information

PFI-9602-<I>

Option I: IEPE Current Source
(Requires PFI-IEPE-9602 Adapter)

2-Channel Filter/Amplifier Module

PFI-9602 Channel Block Diagram

