



Precision 28302B-FX02 Dual Vibration Amplifier for Rotating Machinery

The Precision 28302B-FX02 Dual Vibration Amplifier is designed to condition signals from rotating machinery. The card accepts inputs from single-ended or differential piezoelectric accelerometers, IEPE accelerometers, or remote velocity sensors.

Fixed AC and DC sensitivities are provided in engineering units for acceleration, velocity, or displacement. Programmable high-pass and low-pass filtering is provided for filtering the acceleration, velocity or displacement signals.

Programming of the unit is accomplished via the Ethernet or via the 28000 graphical user interface resident on a host computer.

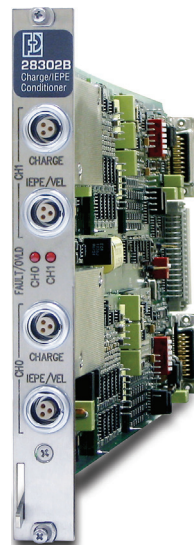

28302B-FX02 Features

- Two channels per card:
 - 32 channels per 28016 chassis
 - 16 channels per 28008 chassis
- Isolated or grounded single-ended Piezoelectric input
- Balanced differential Piezoelectric input
- IEPE input with IEPE power
- Remote charge converter (RCC) input w/IEPE power
- Remote velocity sensor input
- Five filtered AC outputs: two acceleration, two velocity and one displacement
- One DC output: acceleration, velocity or displacement
- Programmable alarm level with relay contact output measures acceleration, velocity or displacement levels.
- Internal shunt calibration capacitors with 0.1% accuracy
- Three overload detectors:
 - Charge Converter
 - Pre-Filter
 - Displacement Out
- Channel Mute function places channel in low noise state if an accelerometer fails during a test run

28302B Input Characteristics

Piezoelectric Inputs

Type:

Single-ended (isolated or grounded) or balanced differential

Sensor Sensitivity:

1 pC/g to 200 pC/g

Maximum Input:

110,000 pC

Source Capacitance:

≤20 nF meets all specifications

Source Resistance:

≥10 kΩ meets all specifications

CMRR (Diff Mode):

>60 dB, 10 Hz to 1 kHz

Ground Signal Rejection (ISO Mode):

>50 dB, 60 Hz to 1 kHz

Noise (RMS 100 kHz measured BW):

0.025 pC + 0.003 pC/nF (RTI)

Shunt Calibration Input:

Precise shunt calibration capacitors inject the test bus signal to the charge input. The calibration signal can be used to verify proper transfer sensitivity of acceleration, velocity and displacement outputs.

Shunt Cal Capacitance:

10000 pF ±0.3% (Calibrated value with 0.12% measurement uncertainty stored in card EEPROM)

Maximum Input:

10 V pk (from System Test Bus)

Input Characteristics continued on page 2

Overview

28000 Analog Signal Conditioning System

The new standard for the world's most discriminating test labs.

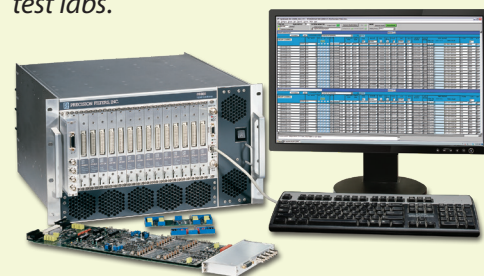

The Precision 28000 signal conditioning system provides all the flexibility you need to manage your test measurements.

The Precision 28000 makes it easy to manage a test, with hundreds of channels and a mix of transducers. Choose charge, IEPE w/TEDS, voltage (filter amplifier), strain, thermocouple, RTD, potentiometer, current, frequency, or other transducers.

The built-in test hardware and software (optional) provide quick Go/No-Go tests, which can be run before each test, and rigorous Factory Acceptance Tests to assure you that the 28000 meets your most stringent requirements for critical applications. It won't be long before these tests earn a permanent place in your maintenance routine. And since they are traceable to NIST, they eliminate the need for off-site calibration.

In every phase of your tests—record keeping, installation, design, set-up, operation, maintenance, and upgrading—the Precision 28000 offers ways to help you save time and money over the life of the system.

28000 System Features

- Graphical user interface (GUI) and Ethernet network interface for system control
- Intelligent gain and system scaling algorithms
- Test input and output monitor busses
- Go/No-Go test with diagnostics to be used before tests
- Rigorous Factory Acceptance Test for maintenance
- Field-swappable AC power supplies
- Built-in temperature and power supply monitoring with alarms

Precision 28302B-FX02 Description

IEPE Input Characteristics

Constant Current:

8.5 mA ±10%

Compliance Voltage:

26 V (24 V in 28008D-M3 Chassis)

IEPE Sensitivity:

0.1 mV/g to 200 mV/g

Max. AC Input:

±11 V pk

IEPE Noise (10 kHz BW):

Input Noise:

11.4 μV * Sensor sen/10 mV/G

Output Noise:

0.001 g at all sensor sensitivity settings

Velocity Input Characteristics

The 28302B supports direct inputs from velocity sensors.

Type:

Single-ended

Sensor Sensitivity:

2 mV/IPS pk to 200 mV/IPS pk

Max. AC Input:

±11 V pk

Noise (10 kHz BW):

3 μV RTI (Sen < 10 mV/IPS)

Input Filter

A programmable 3-pole low-pass filter reduces large out-band signals caused by transducer resonance peaking which could saturate the sensitivity amplifier.

Input Filter Type:

3-pole Butterworth Low-Pass

Cut-Off Frequency Settings:

5 kHz, 10 kHz or 20 kHz (Programmable)

Frequency Response:

-2% (-0.17 dB) ±0.1 dB @ Fc

Rolloff:

18 dB/Octave

Transfer Characteristics

Input Sensor Sensitivities

PE Input:

1 to 200 pC/g

IEPE:

0.1 to 200 mV/g

Velocity:

1 to 200 mV/IPS

Channel Sensitivity

Acceleration Output:

10 mV pk/g pk

Velocity Output:

100 mV pk/IPS pk

Displacement Out:

0.1 Vpk/mil pk

Fullscale AC Output

Acceleration:

1000 g pk

Velocity:

100 IPS pk

Displacement:

100 mil pk

Noise in Charge Amplifiers

Overall noise of charge amplifiers is heavily influenced by input impedance characteristics of the accelerometer and input cabling. The 28302B input stage was designed to minimize these effects and still maintain an operating bandwidth of 0.3 Hz to 20 kHz. The noise plot to the left describes typical noise characteristics throughout the range of sensor sensitivities (1 to 200 pC/g). As input impedances worsen due to long input cables or low impedance accelerometers, additional noise will result. The plots below describe additional noise caused by these effects. Total channel noise can be determined by combining these additional effects with the typical noise such that total noise = $\sqrt{Tn^2 + Rn^2 + Cn^2}$.

Tn = Typical noise

Rn = Additional noise caused by input resistance

Cn = Additional noise caused by input capacitance

28302B Typical Input Referred Noise Vs Sensor Sensitivity Setting

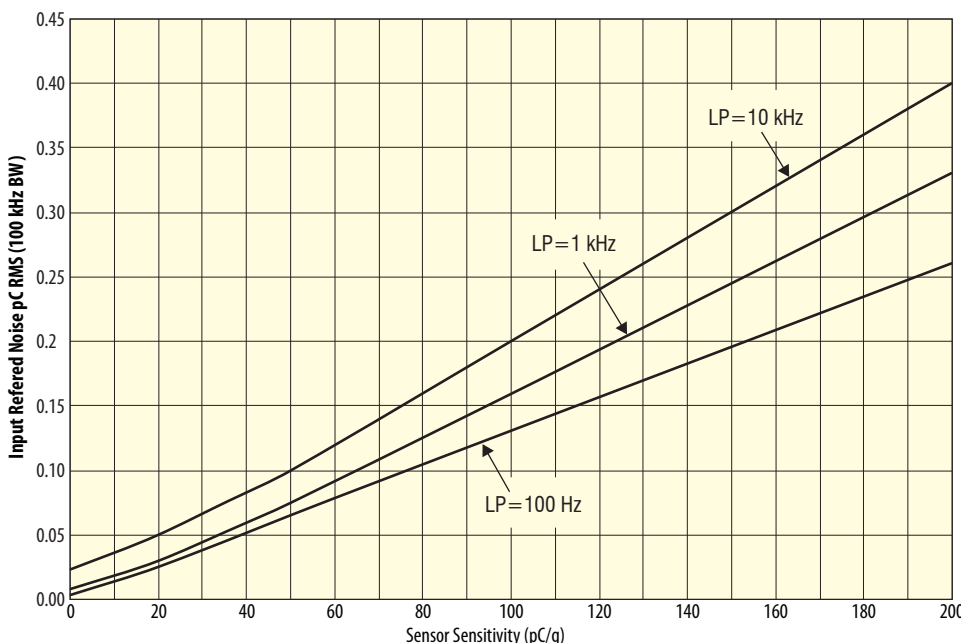

Additional Input Noise Caused by Input Capacitance

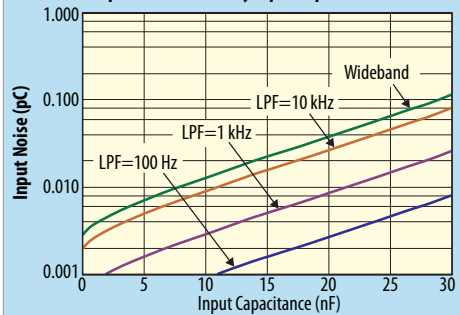

Additional Input Noise Caused by Accelerometer Shunt Resistance

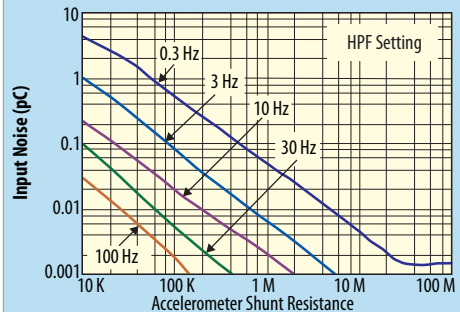

High Temperature Accelerometers

One special category of measurements on rotating machinery involves accurate vibration measurements in extreme high temperature environments such as those experienced on aircraft gas turbine engines. The manufacturers of accelerometers have responded to this need with high temperature accelerometers that operate at temperatures as high as 1200° F (650° C). One common characteristic of all high temperature accelerometers is a significant decrease in shunt resistance across the piezoelectric element at elevated

temperatures. Since a typical charge amplifier is modeled as an amplifier with capacitive feedback, it is extremely sensitive to input shunt resistance and can exhibit severe degradation of low-frequency signal performance as well as amplification of low frequency noise. It is common for a standard charge amplifier to have up to 20 dB amplitude peaks and more than 50 degrees of phase error within the intended operating bandwidth due to the effects of high temperature accelerometers. It is important, therefore, for the test engineer not only to

select a high temperature accelerometer suitable for the job, but also a charge amplifier that can tolerate low shunt resistive effects of the accelerometer.

The 28302B charge converter input stage was designed to tolerate the low shunt resistance effects of high temperature accelerometers. As shown on the plots below, the 28302B has less than 0.1 dB amplitude error ($\approx 1\%$) and 5 degrees of phase error at 3.3 Hz with input shunt resistance as low as 10 Kohms.

Amplitude Response Error Caused by Accelerometer Shunt Resistance

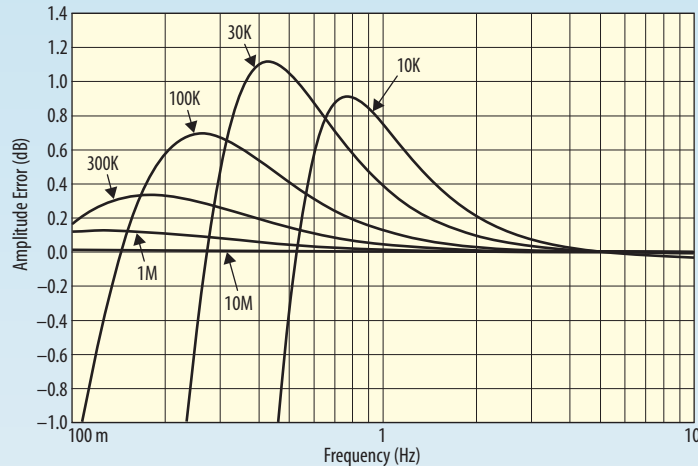

Phase Error Caused by Accelerometer Shunt Resistance

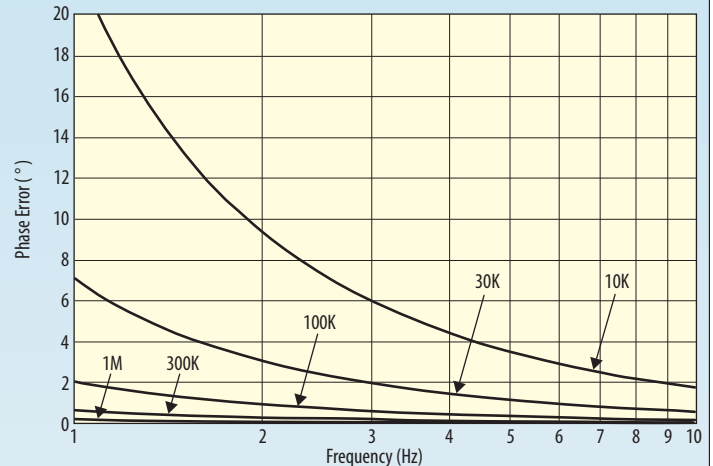

Precision 28302B-FX02 Description

Programmable High-Pass Filter

The 28302B has a programmable Butterworth high-pass filter at the output of the sensitivity amplifier. This filter is useful for reducing low frequency noise and removing out-band signals which could saturate due to the large low frequency gain of the velocity and displacement integrators. The programmable high-pass filter can be selected to one of five unique high-pass filter settings. Filter settings of the 28302-FX02 are shown on the table to the right.

28302B-FX02 Filter Settings					
Filter Number	Filter Name (ID)	Type	Filter Order	Filter Cut-Off (-3 dB)	-2% Frequency
1	HP7-0.3 Hz	Butterworth	7	0.3 Hz	0.38 Hz
2	HP6-3 Hz	Butterworth	6	2.30 Hz	3 Hz
3	HP6-10 Hz	Butterworth	6	7.66 Hz	10 Hz
4	HP6-30 Hz	Butterworth	6	23.0 Hz	30 Hz
5	HP6-100 Hz	Butterworth	6	76.6 Hz	100 Hz

Cut-Off Accuracy:

- 2% (-0.17 dB) \pm 0.1 dB ($F_c > 1$ Hz)
- \pm 0.2 dB ($F_c < 1$ Hz)

Phase Match:

- Channel to channel same cut-off setting:
- 1° typical, 2° max

High-Pass Filter Amplitude Response

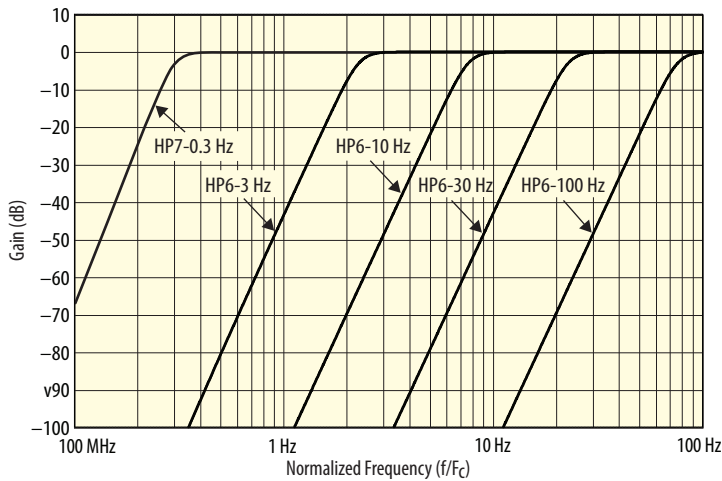

Low-Pass Filter Amplitude Response

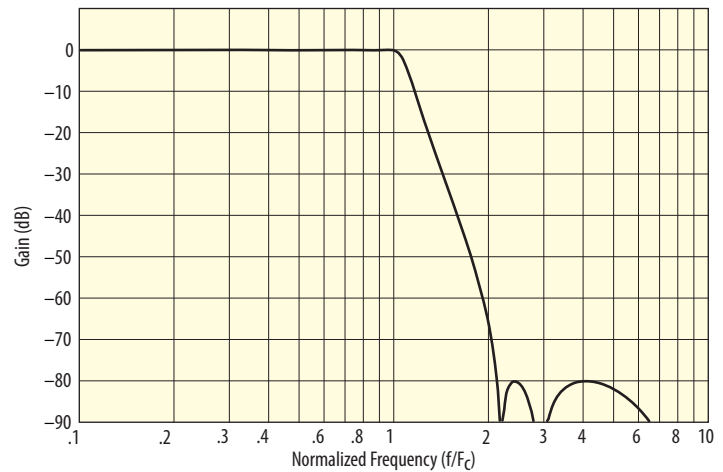

6 and 7-Pole Butterworth High-Pass Filter Passband Response

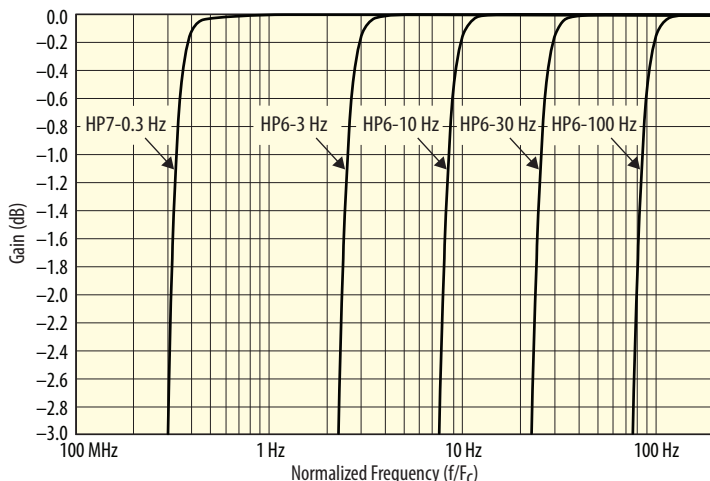

Low-Pass Filter Passband

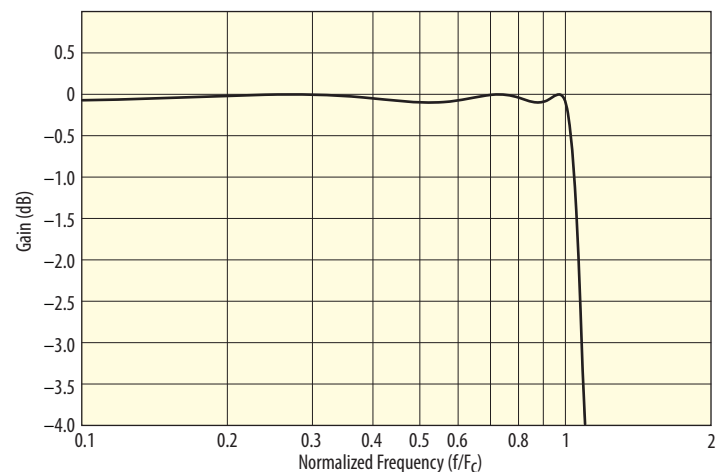

Programmable Low-Pass Filter

A 6-pole, 6-zero Elliptic Low Pass Filter (LPF) is included for each channel and can be inserted via GUI control into the signal path at any one of three locations.

All Outputs:

Inserts the LPF directly at the Sensitivity Amplifier output. The LPF effects the Acceleration output as well as the input to the Velocity Integrator.

Acceleration Only Output:

Inserts the LPF into the Acceleration output only. Velocity and Displacement signals are not effected by the LPF.

Low-Pass Filter Specifications:

Cut-off frequency settings:
50 Hz to 12,750 Hz in 50 Hz steps

Frequency Response:

$\pm 1\%$ 0.3 Hz to Fc
-3 dB ± 0.25 dB at $1.0808 * Fc$
<60 dB at $2 * Fc$

Phase Match:

Channel to channel same cut-off setting:
1° typical, 2° max

DC Offset:

± 1 mV max

Noise:

75 μ V RMS

Simplified Block Diagram of a Single Channel of the 28302B-FX02

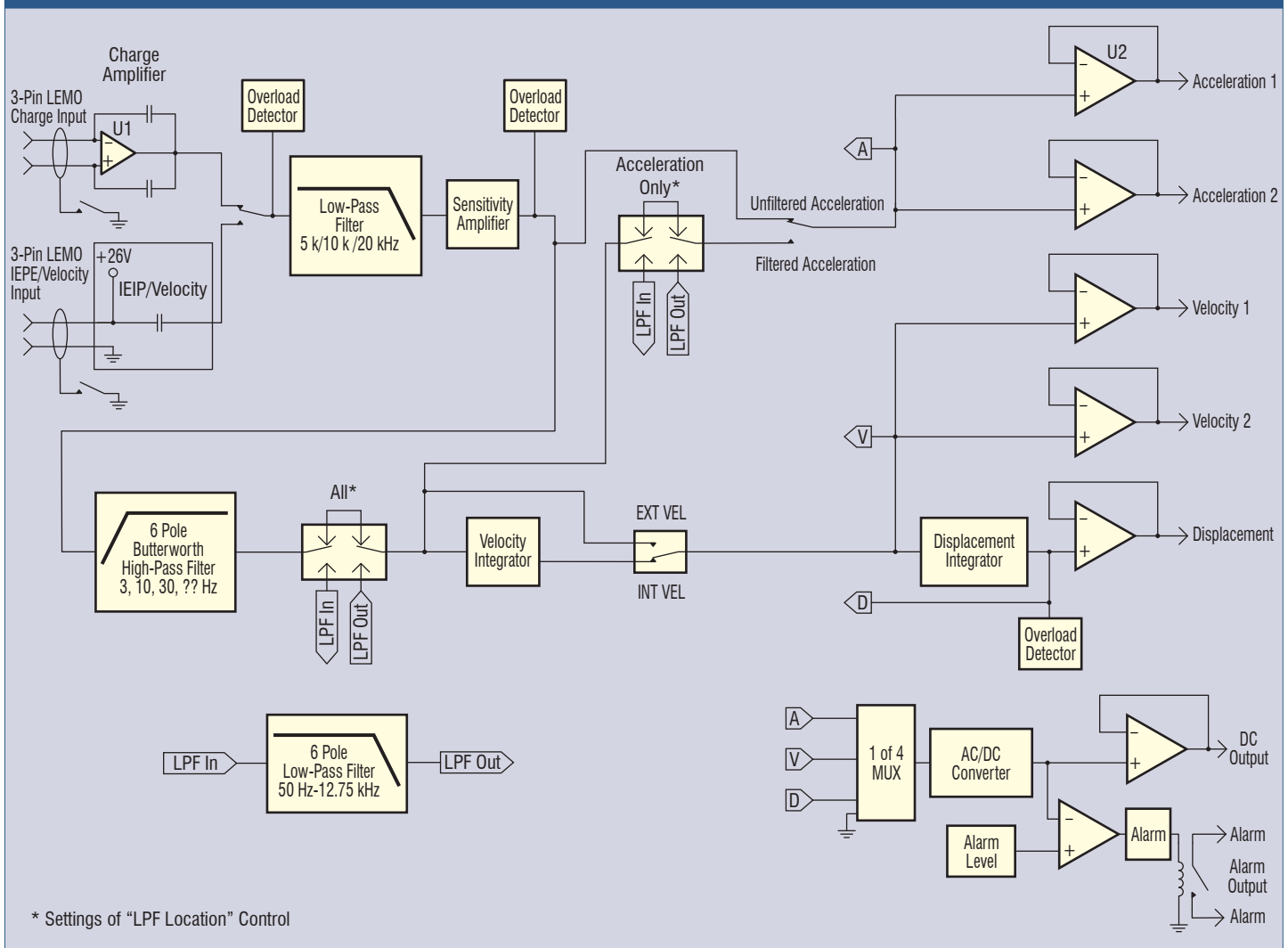

Precision 28302B-FX02 Description

Alarm

Programmable level detector connected to the DC output.

Level:

Programmable 1% to 100% of fullscale

Accuracy:

$\pm 0.25\%$ and ± 1 mV of setting

Response Time:

1 second

Actuation:

Relay closure per channel for remote facility alarm. Front panel LED and GUI indication with entry into time stamped log file.

MUTE Mode

It is common in the harsh environment of rotating machinery that a sensor or input cable can become faulty or intermittent during a critical test. With high gain signal conditioning this can be troublesome if large signal swings on input or output cabling cross couples to other channels.

The 28302B Channel MUTE Mode places the channel in the quietest operational state to minimize system noise in the event of a failed sensor. A muted channel is clearly identified on the GUI panel and can coexist in a control group without being cleared by other commonly used group commands. A muted channel can be returned to operational mode at any time and all configuration settings will be restored.

28302B Output Characteristics

All outputs are single-ended, short circuit protected, with output sense or low-side grounded, selected by an on card slide switch. The outputs will drive a 1 k Ω and 30,000 pF load (1000 foot cable) with 50 Ω output impedance.

Acceleration AC Output

(2 outputs)

Acceleration Sensitivity:

10 mV pk/g pk (independent of sensor sensitivity)

Fullscale Acceleration Level:

1000 g (for Sen <100 pC/g)
1000 g * (100/Sen) (for Sen > 100 pC/g)

Linear V Range:

0 to ± 10 V pk

Output Offset:

± 5 mV max

Bandwidth:

-2% (-0.17 dB) at programmed HPF and acceleration BW settings.

Mid Band Gain Accuracy:

$\pm 0.5\%$ at any gain setting, measured at 100 Hz. (without 6-pole LPF)

Velocity AC Output

(2 outputs)

Velocity Sensitivity:

100 mV pk per IPS pk (independent of sensor sensitivity)

Fullscale Velocity Level:

100 IPS pk

Linear V Range:

0 to ± 10 V pk

Output Offset:

± 5 mV max

Integrator Gain Accuracy:

$\pm 0.1\%$ referred to Acceleration output

Bandwidth:

5 Hz to 20 kHz

Low frequency roll-off:

-6 dB/Octave below 4.32 Hz

Displacement AC Output

Displacement Sensitivity:

0.1 Vpk per mil pk

Fullscale Displacement Level:

10 mil pk

Linear V Range:

0 to ± 10 V pk

Output Offset:

± 12.5 mV max

Integrator Gain Accuracy:

$\pm 0.1\%$ referred to Velocity Output

Bandwidth:

5 Hz to 20 kHz

Low frequency roll-off:

-6 dB/Octave below HPF setting

Note: Displacement Integrator is muted (no output) for HPF = 0.3 Hz

DC Output

An AC-to-DC converter stage is provided for each channel and can be connected to the acceleration, velocity or displacement signal.

Sensitivities:

Acceleration:
10 mV DC per g pk

Velocity:

100 mV DC per IPS pk

Displacement:

0.1 VDC per mil pk

Accuracy (relative to selected output):

$\pm 0.25\%$ 10 Hz to 10 kHz ($V_o > 1$ V pk)
 $\pm 1.0\%$ ($V_o > 0.1$ V pk)

Ripple:

(pk-pk) = V_o (DC) / (1.8 * $(F_{1N})^2$) pk-pk

Offset:

± 5 mV max

Drift:

50 μ V/ $^{\circ}$ C



Option 0 Input Connectors



Standard Input Connectors

Connectors

Input Connectors

Standard

Four LEMO connectors on the front panel provide inputs for two IEPE and two Charge input sources.

IEPE Input:
3-Pin LEMO

Charge Input:
3-Pin LEMO

Connector Type:
LEMO pn: FGG.1B.303.CYB.D??

Option 0

Four input connectors on the front panel. Two co-axial BNC connectors provide input for two IEPE input sources and two twinaxial BNC connectors provide input for two Charge input sources.

IEPE Input:
Co-axial BNC

Charge Input:
Twinaxial BNC

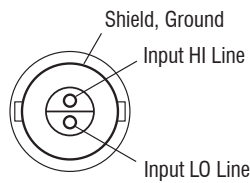

CHARGE
Twinaxial-BNC
Connector

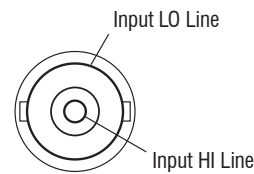

IEPE/VEL
BNC Connector

Output Connector

The output connector on the 28302B card extend through the 28000 rear chassis panel cut-outs and directly mate with the mating connectors attached to the chassis panel.

All seven output signals are provided on one high-density 26-pin D-shell per channel

Mating Connector:

Available mating connectors for the 28302B card are described on the next page under the Accessories section.

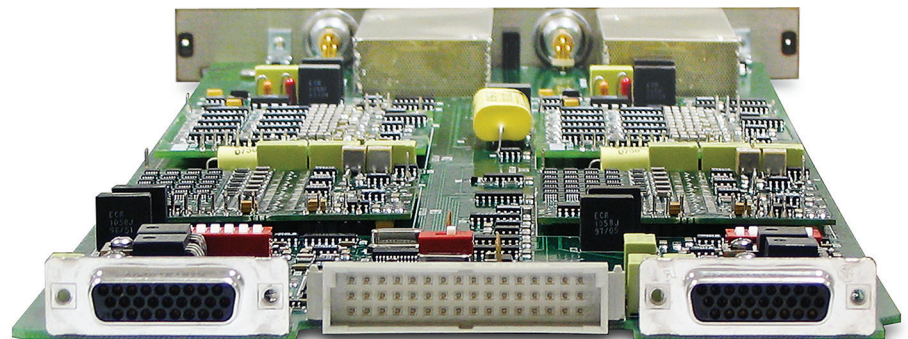

28302B Output Connectors

28302B General Characteristics

28302B Card Size:

6.6 x 17.5 x 0.75 inches

Card Weight:

1.5 lb. net

Temperature:

40°F to 125°F (5°C to 52°C) (operating)
-40°F to 185°F (-40°C to 85°C) (storage)

Humidity:

95% R.H., non-condensing

Power:

±15 VDC: 200 mA
+28 VDC: 25 mA
+5 VDC: 100 mA

Accessories

Mating Connectors

Input Mating Connectors

CONN-IN-LEMO-FGG.1B.303: PF pn A10861 consisting of LEMO pn FGG.1B.303.CYB.D?? (where ?? indicates ferrule size). A set of ferrules for cable O.D. 0.06 to 0.22 inches is provided. Crimp pins accommodate 20, 22 or 24 gage wire (AWG).

Output Mating Connectors

Output mating connectors accommodate up to 22-AWG wire and are supplied with high quality metal backshells and gold plated screw machined contacts for high reliability connections and long service life.

CONN-OUT-26D: High-Density 26-pin D-shell mating output connector with machined crimp pins and metal backshell with strain relief.

CONN-OUT-26D-SC: High-Density 26-pin D-shell mating output connector with machined solder cup pins and metal backshell with strain relief.

Precision Product Solutions

For over 40 years, Precision Filters has been a global provider of instrumentation for test measurements. You can rely on a single source for signal conditioning and switching—*a complete range of instrumentation*—products optimized to work together to provide high performance at reasonable cost.

Precision Products

Precision PF-1U-FA Multi-Channel Programmable Filter/Amplifier System



Exceptional desktop performance at low cost.

Ideal for conditioning low-level voltage inputs in front of high-resolution digital data acquisition systems. Fully programmable 8-channel and 16-channel configurations are available, both offering a choice of either 4- or 8-pole low-pass filters with programmable gain.

464kC High-Density Programmable Switch Matrix



Computer-controlled analog signal switching replaces tedious manual patch panels.

The 464kC is a reliable solid-state switch matrix system that provides computer-controlled connection between 256 inputs and 256 outputs, all in a single mainframe. Save time and reduce errors on test system setup. Download switch configurations from the host computer over the network. Built-in self-test with fault diagnostics.

28302B Card Model Number

The 28302B-FX02 card model number describes the high-pass filter range and input connector options.

28302B-<High-Pass Filter Range>- Options

0: Coaxial and Twinaxial Input Connectors

FX01: 0.3 Hz (7-pole), 3.3 Hz (6-pole), 6 Hz, 15 Hz, 70 Hz (10-pole)

FX02: 0.3 Hz (7-pole), 3 Hz, 10 Hz, 30 Hz, 100 Hz (6-pole)